

EFFECTIVENESS OF FLOW-EXCITED HELMHOLTZ RESONATOR ON TURBULENCE STRUCTURES IN STREAMWISE AND SPANWISE DIRECTIONS

Farzin Ghanadi

farzin.ghanadi@adelaide.edu.au

Maziar Arjomandi

maziar.arjomandi@adelaide.edu.au

Ben Cazzolato

benjamin.cazzolato@adelaide.edu.au

Anthony Zander

anthony.zander@adelaide.edu.au

School of Mechanical Engineering
University of Adelaide
SA 5005, Australia

ABSTRACT

This paper evaluates the capability of a flow-excited cylindrical Helmholtz resonator for the manipulation of the disturbances within a three dimensional turbulent boundary layer in the streamwise and spanwise directions. A detailed investigation of the characteristics of the boundary layer downstream of the resonator has been accomplished through an extensive experimental study. The results showed that a reduction in the turbulence intensity of the streamwise velocity fluctuations and sweep events occurs immediately downstream of the resonator but this effect dissipates further away from the resonator orifice. This was hypothesized to be due to thinning of the boundary layer thickness downstream of the resonator in the streamwise direction and weakening of the spanwise vortices generated by the resonator. The results presented in this paper provide an improved understanding for further development of multiple adjacent resonators over an area as a possible alternative system for the purpose of turbulent flow control.

Introduction

Under certain conditions the flow past a Helmholtz resonator results in self-sustained resonance. At resonance, the large amplitude of the pressure fluctuations within the flow excited by a Helmholtz resonator induces a force into the shear flow to relieve the pressure inside the resonator cavity (Panton and Miller 1975; Nelson et al. 1981; Ma et al. 2009; Ghanadi et al. 2014a). This process can produce a small velocity pulsation, thereby manipulating the shear layer which is developed over the resonator orifice. The frequency and amplitude of the flow fluctuations over the resonator can also be altered by

changing the characteristics of the resonator, such as the cavity volume and the orifice size, and the incoming flow conditions.

The flow oscillation over the Helmholtz resonator has gained renewed interest due to its diverse industrial applications (Hemon et al. 2004; Massenzio et al. 2008). The flow oscillations generated by the resonator may have undesirable effects; for instance, gas fluctuations inside pipelines with closed side branches, the grazing flow over an aircraft landing gear bay, and cabin pressure fluctuations inside a vehicle with an open window or sunroof (Bruggeman et al. 1991; Inagaki et al. 2002; Crouse et al. 2006). However, it was observed that the oscillatory flow over the resonator can attenuate the instabilities within the turbulent boundary layer downstream of the resonator (Ghanadi et al. 2014b). It was demonstrated that at resonance, flow induced pulsation in the vicinity of the resonator orifice may inhibit the growth of the coherent structures and stabilise the turbulent boundary layer. In this method, the energy required for manipulation of the low momentum flow and associated streamwise vortices is extracted from the grazing flow and is returned to it almost entirely as periodic fluctuations. Therefore, the Helmholtz resonator can potentially be used as a passive wall-based flow control device since it does not need an external energy source to be activated. However, it is necessary to identify the streamwise and spanwise extents over which stability improvements are maintained. Thus, understanding the underlying physics of the flow within the boundary layer in the vicinity of the resonator orifice is of paramount importance. This paper through an experimental investigation has identified the maximum downstream distances in which a cylindrical flow-excited Helmholtz resonator can reduce the turbulent energy production within the boundary layer.

Experimental procedure

All measurements have been conducted in a closed-return-type wind tunnel, with a rectangular test section of 2m long and a cross-section of 50cm \times 50cm. The flow velocity was varied between 0m/s to 30m/s, with a low level of turbulence intensity ranging between 0.3% to 0.7%. To minimize any possible flow separation due to the finite thickness of the flat plate a super-elliptical leading edge was attached to the flat plate. A 12.5cm long circulation flap downstream of the plate was mounted to minimize circulation developed over the plate. Pressure tappings were also installed in the roof of the test section to measure the pressure variation along the test flat plate. Throughout the investigations the pressure variation along the working section was less than $\pm 0.5\%$. A cylindrical Helmholtz resonator was positioned underneath the flat plate and was set flush to the surface at a distance of 35cm from the leading edge. To ensure a fully developed turbulent boundary layer over the Helmholtz resonator the boundary layer was tripped by a circular rod with a 3mm diameter placed close to the leading edge of the plate. To characterise the velocity fields in the vicinity of the resonator orifice a hot-wire anemometer with a single wire and minimum thermal effects was utilized. To achieve appropriate temporal resolution of each measurement a sampling rate of 10kHz with a recording time of 10sec was applied. As illustrated in Figure 1, three different locations in both the streamwise (ST1 to ST3) and spanwise (SP1 to SP3) directions have been selected to investigate the maximum distances affected by the resonators.

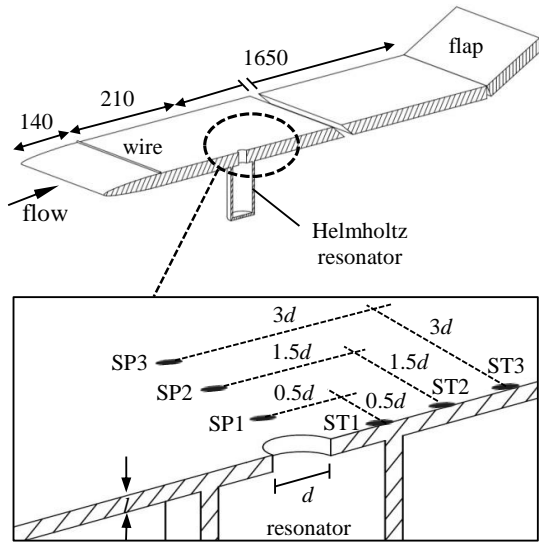

Figure 1. Schematic of cross-section experimental setup and the locations for measurements.

The parametric study undertaken by Ghanadi et al. (2014b) in the previous experimental investigations showed that almost no excitation of the pressure field occurred when the ratio of the cavity depth (L) to diameter (D) of the Helmholtz resonator is less than 4. It was also observed that when the orifice length (l) equals the boundary layer thickness (δ) and the orifice diameter (d) approaches the thickness of the inner layer of the

boundary layer, $d \approx 300 \nu / u_\tau$, the resonator can reduce the instabilities within the turbulent boundary layer. Therefore, as presented in Table 1, two different Helmholtz resonators were investigated in this paper.

Table 1. Characteristics of the resonators and their resonance frequencies. The depth and diameter of the cavity are 100 mm and 25 mm in all cases.

Helmholtz resonator designation	l (mm)	d (mm)	Resonance frequency (Hz)
HR1	5	5	398
HR2	15	10	550

The streamwise mean velocity and turbulence intensity were compared against published data (Marusic & Kunkel 2003; Klewicki et al. 2009; Sillero et al. 2013) to verify that the turbulent boundary layer over the resonators is fully developed. For validation purposes in this paper the DNS results obtained by Sillero et al. (2013) have been chosen because they investigated the properties of the turbulent boundary layer with a high degree of accuracy over a wide range of Reynolds numbers. Figure 2 shows that there is a relatively good agreement between the experimental results and the published data obtained from DNS for the mean and the fluctuation velocity when $y^+ > 20$.

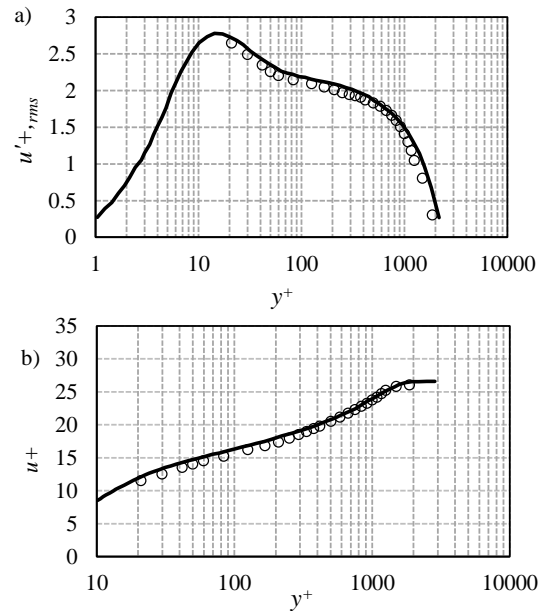

Figure 2. Streamwise velocity profiles of the incoming turbulent boundary layer upstream of the resonator at $Re_\theta = 5000$, a) velocity fluctuating; b) mean velocity; (solid line) DNS by Sillero et al. (2013) and (circle) present investigation.

The investigations undertaken by Ghanadi et al. (2014b) demonstrated that the Helmholtz resonator can be excited

when the momentum thickness Reynolds number, Re_θ , over the resonator is more than 1600. Therefore, the characteristics of the boundary layer have been investigated for a range of Re_θ between 1800 to 3000. Table 2, summarizes the typical boundary layer parameters of the incoming turbulent flow for two different flow velocities. The superscript '+' denotes the time scale (ν/u_τ^2) or the length scale (ν/u_τ), where ν and u_τ are the kinematic viscosity and friction velocity, respectively. The instantaneous streamwise velocity components is represented by u and the momentum thickness is denoted by θ . The shape factor is also represented by H .

Table 2. Characteristics of incoming turbulent boundary layer.

u_τ (m/s)	θ (mm)	Re_θ	H
0.8	1.7	1800	1.37
1.1	1.9	3000	1.35

To provide a detailed measure of the characteristics of the turbulent boundary layer in the vicinity of the resonators, the averaged turbulence intensity of velocity fluctuations, u^+_{rms} , and the changes in duration and intensity of the turbulent events at different locations in the streamwise and the spanwise directions were compared against the no-resonator case.

Reduction of turbulence intensity in streamwise and spanwise directions

Attenuation of instabilities within a turbulent boundary layer can be investigated by looking at the streamwise velocity fluctuation within the viscous and logarithmic regions (Pang & Choi 2004; Lee & Choi 2008). The results obtained by Ghanadi et al. (2014b) showed a reduction in the streamwise turbulence intensity downstream of the resonators presented in this paper. However, the maximum distance in which the resonators can reduce the turbulence intensity were not identified.

As can be seen in Figure 3(a), in the streamwise direction a significant reduction of up to 16% in the turbulence intensity occurs immediately downstream of HR1, and can still be observed at the location ST2 ($1.5d$) when $Re_\theta=1800$. This demonstrates that the maximum extent of the streamwise variation is almost equal to the thickness of the logarithmic region of the boundary layer. However, at the measurement location further away from the trailing edge of the resonator orifice (ST3 $\equiv 3d$), the turbulence intensity values within the logarithmic region of the boundary layer are not significantly altered compared with the no-resonator case. The turbulence intensity of the streamwise velocity fluctuations downstream of HR2 was also analysed, and it was observed that this resonator reduces the velocity fluctuation within the turbulent boundary layer by a maximum of 12% for the distances up to $y^+=200$ at ST1 and ST2 (Figure 3b). The slight pressure fluctuations within the orifice neck of HR2 have minimal effect on the velocity fluctuations within the boundary layer and then the turbulence intensity is unchanged beyond $1.5d$ from the resonator orifice.

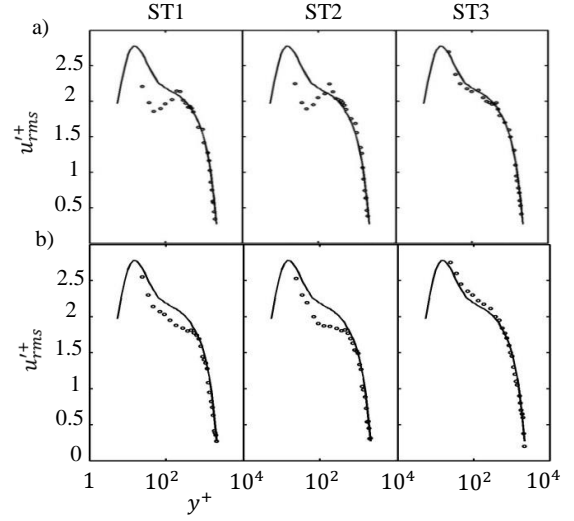

Figure 3. Turbulence intensity profiles within the boundary layer downstream of the resonators at different streamwise locations when $Re_\theta=1800$; a) HR1 and b) HR2; with resonator (circle), no-resonator case (solid line).

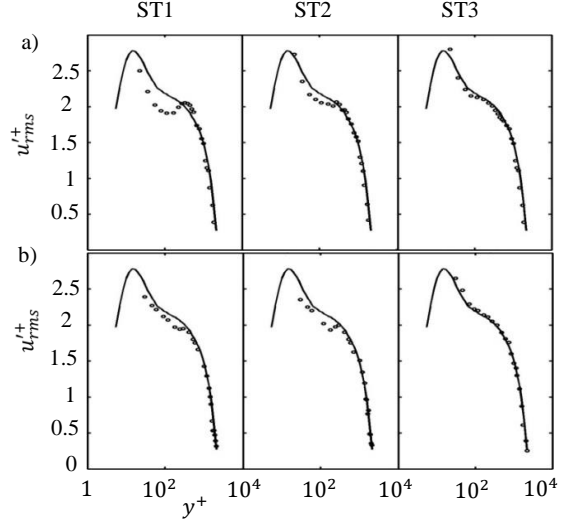

Figure 4. Turbulence intensity profiles within the boundary layer downstream of the resonators at different streamwise locations when $Re_\theta=3000$; a) HR1 and b) HR2; with resonator (circle), no-resonator case (solid line).

The effect of HR1 is not observed at a distance of approximately $2d$ downstream of the resonator when $Re_\theta=3000$ (Figure 4a). It is thought that this is due to the amplification of the velocity fluctuations within the boundary layer at this flow velocity which results in weakening of the resonator effects further away from the trailing edge of the resonator orifice. As shown in Figure 4(b), stabilisation effect of HR2 is also slightly decreased at ST1. It is postulated that higher flow velocity causes greater pressure fluctuations within this resonator and increases the flow injection in the vicinity of the resonator. The results also show that at $Re_\theta=3000$ the

flow suction and injection over the resonator cannot affect the boundary layer at further away from the resonator orifice ($ST3 \equiv 3d$).

The local influence of HR1 on the boundary layer has also been analysed in the spanwise direction. The results presented in Figure 5(a) show that at $Re_\theta = 1800$ the boundary layer is only modified by up to 8% in the vicinity of the orifice and the instabilities at the locations away from the orifice edge (SP2 and SP3) are essentially unaffected. Hence, it was concluded that the favourable effect of this resonator in the streamwise direction is greater compared with the changes in instabilities within the boundary layer in the spanwise direction. Moreover, the area affected by the resonator in spanwise direction is less than for the streamwise direction. As shown in Figure 5(b), the modification of velocity fluctuations through HR2 is also reduced in spanwise direction such that the turbulence intensity in three locations (SP1, SP2 and SP3) remains unaltered. It must be also stated that increasing Reynolds number to $Re_\theta = 3000$ reduces the effectiveness of both resonators on the turbulence intensity in all locations in spanwise direction.

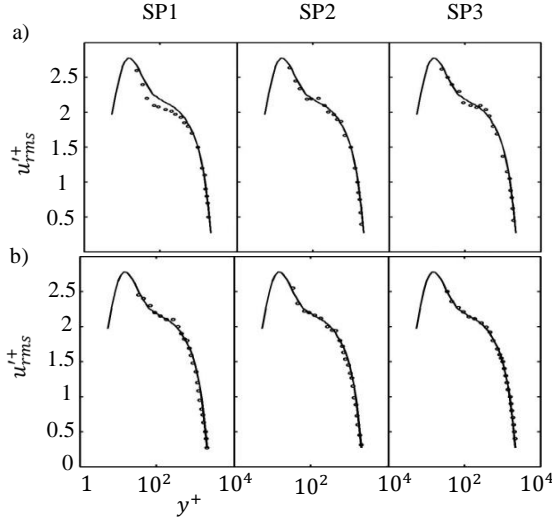

Figure 5. Turbulence intensity profiles within the boundary layer downstream of the resonators at different spanwise locations when $Re_\theta = 1800$; a) HR1 and b) HR2; with resonator (circle), no-resonator case (solid line).

Modification of turbulent events in streamwise and spanwise directions

The strong velocity fluctuations within the turbulent boundary layer come from the turbulent events. It was observed that burst-sweep cycles are the major contributor to increase the instabilities within the boundary layer (Hooshmand et al. 1983; Choi 2002). Therefore, in most previous studies on flow control techniques, such as spanwise wall oscillation and travelling wave techniques the investigations have focused on reducing the intensity and duration of the sweep events to attenuate the turbulence energy production within the boundary layer (Choi and Clayton 2001; Jukes et al. 2006; Whalley 2011). In this study to assess the influence of the flow-excited resonator on the structure of the turbulent boundary layer in more detail, the intensity and duration of the sweep events have

been also investigated. Using the Variable-Interval Time-Averaging (VITA) technique (Blackwelder and Kaplan 1976), attenuation of the sweep events was analysed at one spatial location in which the maximum reduction in turbulence intensity occurs, $y^+ = 35$. In this method to investigate the changes in the structure of the boundary layer a small window must be moved across the streamwise velocity fluctuation signal. The sweep and ejection events are accurately detected when the ratio of variance of the small window to the variance of the entire signal is larger than a threshold value which is usually set to 1.2. To have results with high fidelity the size of the small window in this study was set to $T_w^+ = T_w u_\tau^2 / \nu = 10$ and the average was calculated in a small window of size $T_{ave}^+ = -20$ to 20 centred at the maximum value of the velocity gradient. For the purpose of validation of the calculated intensity and duration of one sweep event within a fully developed turbulent boundary layer, the results were compared with the published experimental results obtained by Whalley (2011). As can be seen in Figure 6(a) the multiple individual events over the small time window have been detected. The average of the VITA sweep events within this window is in good agreement with the published data (Figure 6b).

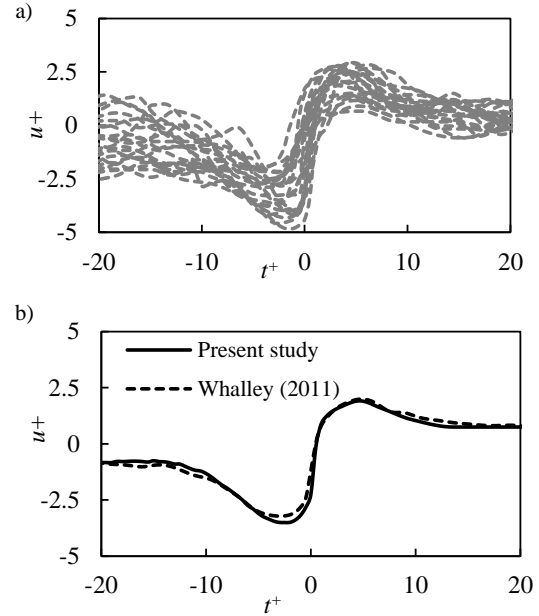

Figure 6. VITA events at $y^+ = 35$ for unexcited boundary layer when $Re_\theta = 1800$; (a) sweep events and (b) averaged VITA sweep event.

The time difference between the peaks during the averaged VITA sweep event is the duration (Δt^+) and the peak to peak value of the event reveals the intensity (Δu^+). Figure 7(a) shows an 11% and a 5% reduction in sweep intensity downstream of HR1 and HR2 at ST1, with the significantly less reduction further from the resonator orifice at ST2 and ST3. As can be seen in Figure 7(b), a slight reduction in the duration of the sweep events also occurs very close to the orifice edge of both resonators (at ST1), although the modification decays at ST2 ($1.5d$) and ST3 ($3d$). This is thought to be due to the

fact that at the locations further away from the trailing edge of the resonator orifice the sweep events are regenerated and therefore the resonator effect is damped.

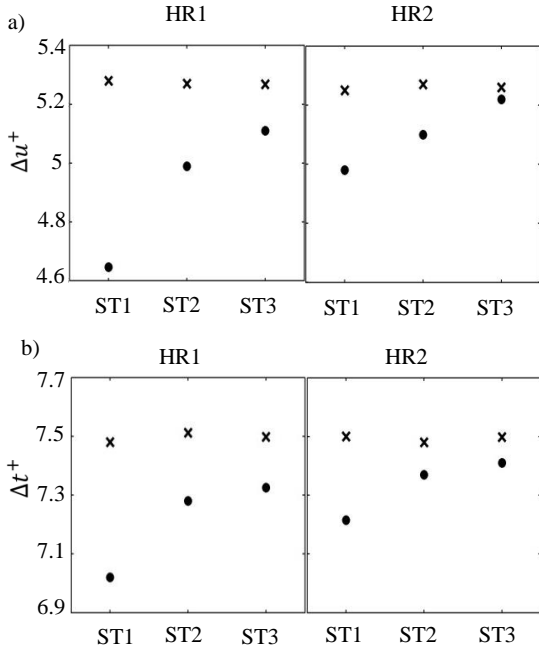

Figure 7. Characteristics of the averaged sweep events downstream of the resonators in the streamwise direction at $y^+ = 35$ when $Re_\theta = 1800$; (a) sweep intensity and (b) sweep duration with resonator (circle), no-resonator case (cross).

In the spanwise direction, neither resonator is able to significantly attenuate the turbulence energy at the locations further away from the orifice edge. As can be seen in Figure 8(a), at SP2 both HR1 and HR2 reduce the sweep intensity by up to 3%. The incoming flow also weakens the resonators effect at SP3 such that the sweep intensity remains unaltered. The duration of sweep events is also dropped significantly at locations further away from the orifice edge in the spanwise directions (Figure 8b). It is postulated that high magnitude of velocity fluctuations within the incoming boundary layer at SP2 and SP3 increases the frequency of burst-sweep cycles and results in decreases in the effectiveness of the resonators.

Further increasing the velocity of the grazing flow affects the sweep structure. The results showed that increasing the Reynolds number to $Re_\theta = 3000$ amplifies the generation of the turbulent events and reduces the area affected by the resonators. Consequently, neither resonator is able to significantly attenuate the turbulence energy at locations beyond $0.5d$ from the orifice edge in the streamwise and spanwise directions.

Conclusion

The Helmholtz resonator creates an oscillatory flow at the surface which can manipulate the near-wall flow and hence, it may be an appropriate device for wall-based flow

control. The present study provides an insight into how the flow behaves in the vicinity of the resonator in the streamwise and spanwise directions to identify maximum extent over which innate disturbances within the boundary layer are reduced.

The results show that when the resonator orifice diameter is equal to the thickness of the inner layer, HR1, the instabilities are not reduced significantly beyond $1.5d$ from the orifice edge in both the streamwise and spanwise directions. However, when the orifice length is equal to the thickness of the boundary layer, as in the case of HR2, the velocity fluctuations are reduced no further than $0.5d$ from the orifice edge in both the streamwise and spanwise directions. Therefore, it is concluded that through the use of a flow-excited Helmholtz resonator the turbulent boundary layer is only stabilized close to the resonator orifice in both the streamwise and spanwise directions. Hence, by incorporating multiple, subsequent and identical resonators in the vicinity of the first, it is anticipated that the stability improvements could be maintained. The results presented in this paper are only the beginning steps for the development of a novel approach to control the turbulent boundary layer.

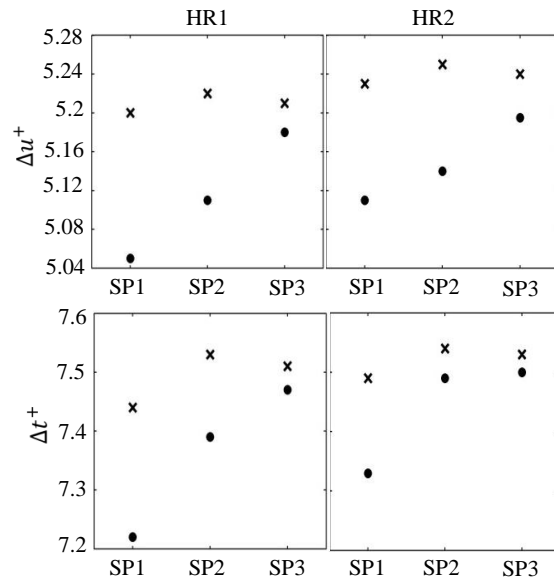

Figure 8. Characteristics of the averaged sweep events in the vicinity of the resonators in the spanwise direction at $y^+ = 35$ when $Re_\theta = 1800$; (a) sweep intensity and (b) sweep duration with resonator (circle), no-resonator case (cross).

References

- Blackwelder, R. F., and Kaplan, R. E., 1976, "On the wall structure of the turbulent boundary layer", *Journal of Fluid Mechanics*, Vol. 76, pp. 89-112.
- Bruggeman, J., Hirschberg, A., Van Dongen, M., Wijnands, A., and Gorter, J., 1991, "Self-sustained aeroacoustic pulsations in gas transport systems: experimental study of the influence of closed side branches", *Journal of Sound and Vibration*, Vol. 150, No. 3, pp. 371-393.
- Choi, K., and Clayton, B. R., 2001, "The mechanism of turbulent drag reduction with wall oscillation",

International Journal of Heat and Fluid Flow, Vol. 22, pp. 1-9.

Crouse, B., Senthooan, S., Freed, D., Balasubramanian, G., Gleason, M., Puskarz, M., Lew, P. and Mongeau, L., 2006, "Experimental and numerical investigation of a flow induced cavity resonance with application to automobile buffeting", *27th AIAA Aeroacoustics Conference*, Massachusetts, USA.

Ghanadi, F., Arjomandi, M., Cazzolato, B. S., and Zander, A. C., 2014a, "Understanding of the flow behaviour on a Helmholtz resonator excited by grazing flow", *International Journal of Computational Fluid Dynamics*, Vol. 28, No. 5, 219–231.

Ghanadi, F., Arjomandi, M., Cazzolato, B. S. and Zander, A. C., 2014b, "Interaction of a flow-excited Helmholtz resonator with a grazing turbulent boundary layer", *Experimental Thermal and Fluid Science*, Vol. 58, pp 80-92.

Hémon, P., Santi, F., and Amandolèse, X., 2004, "On the pressure oscillations inside a deep cavity excited by a grazing airflow", *European Journal of Mechanics-B/Fluids*, Vol. 23, No. 4, pp. 617- 632.

Inagaki, M., Murata, O., Kondoh, T., and Abe, K., 2002, "Numerical prediction of fluid-resonant oscillation at low Mach number", *AIAA Journal*, Vol. 40, No. 9, pp. 1823-1829.

Jukes, T. N., Choi, K. S., Johnson, G. A. and Scott, S. J., 2006, "Turbulent drag reduction by surface plasma through spanwise flow oscillation", *3rd AIAA Flow Control Conference*, Paper No. AIAA-2006-3693, California, USA.

Klewicki, J.C., Fife, P., and Wei, T., 2009, "On the logarithmic mean profile", *Journal of Fluid Mechanics*. Vol. 638, pp. 73–93.

Lee, S. J., and Choi, Y. S., 2008, "Decrement of spanwise vortices by a drag-reducing riblet surface", *Journal of Turbulence*, Vol. 9, pp. 1–15.

Ma, R., Slaboch, P. E., and Morris, S. C., 2009, "Fluid mechanics of the flow-excited Helmholtz resonator", *Journal of Fluid Mechanics*, Vol. 623, pp. 1-26.

Marusic, I., and Kunkel, G. J., 2003, "Streamwise turbulence intensity formulation for flat-plate boundary layers", *Physics of Fluids*, Vol. 15, pp. 2461–2464.

Massenzio, M., Biais, A., and Lesueur, C., 2008, "Mechanisms of self-sustained oscillations induced by a flow over a cavity", *Journal of Vibration and Acoustics*, Vol. 130, No. 5, pp. 1-8.

Nelson, P. A., Halliwell, N. A., and Doak, P. E., 1981, "Fluid dynamics of a flow excited resonance, part I: Experiment", *Journal of Sound and Vibration*, Vol. 78, pp. 15-38.

Pang, J., and Choi, K. S., 2004, "Turbulent drag reduction by Lorentz force oscillation", *Physics of Fluids*, Vol. 16, pp. 35-38.

Panton, R. L., and Miller, J. M., 1975, "Excitation of a Helmholtz resonator by a turbulent boundary layer", *Journal of the Acoustical Society of America*, Vol. 58, pp. 800-806.

Sillero, J., Jiménez, J., and Moser, R.D., 2013, "One-point statistics for turbulent wall-bounded flows at Reynolds numbers up to $\delta^+ \sim 2000$ ", *Physics of Fluids*, Vol 25, No 10, pp. 1-16.

Whalley, R. D., 2011, "Turbulent boundary-layer control with DBD plasma actuators using spanwise

travelling-wave technique", PhD thesis, University of Nottingham.